

Air Cooled CO2/MAG Welding Torch

BLUE TORCH III

OWNER'S MANUAL 『Parts List』

BT3510-30UT...1U6318
 BT3510-45UT...1U6319
 BT3510-60UT...1U6320

BT3510-30UT

BT3510-45UT

BT3510-60UT

■ Rated Specification

Rated Current and Duty Cycle		350A 60%(CO2) / 300A 30%(MAG)		
Torch Length		3.0m/10ft	4.5m/15ft	6.0m/20ft
Net Weight		2.9kg/6.4lb	3.8kg/8.4lb	4.7kg/10.4lb
Diameter range of the electrode ※1	mm	(0.9) , (1.0) 1.2 , (1.4)	(1.0) , 1.2 (1.4)	1.2 , (1.4)
	inch	(.035) , (.040) .045 , (.052)	(.040) , .045 (.052)	.045 , (.052)
Type of the electrode		Mild steel wire , Flux-cored wire		
Type of shielding gas		CO2 , MAG		
Type of cooling		Air Cooled		
Method of guidance		Manual		
Voltage rating		113V(Peak)		
Torch switch technical data		DC30V 3A		

※1:“()”: Optional parts are necessary.

Standard Parts List

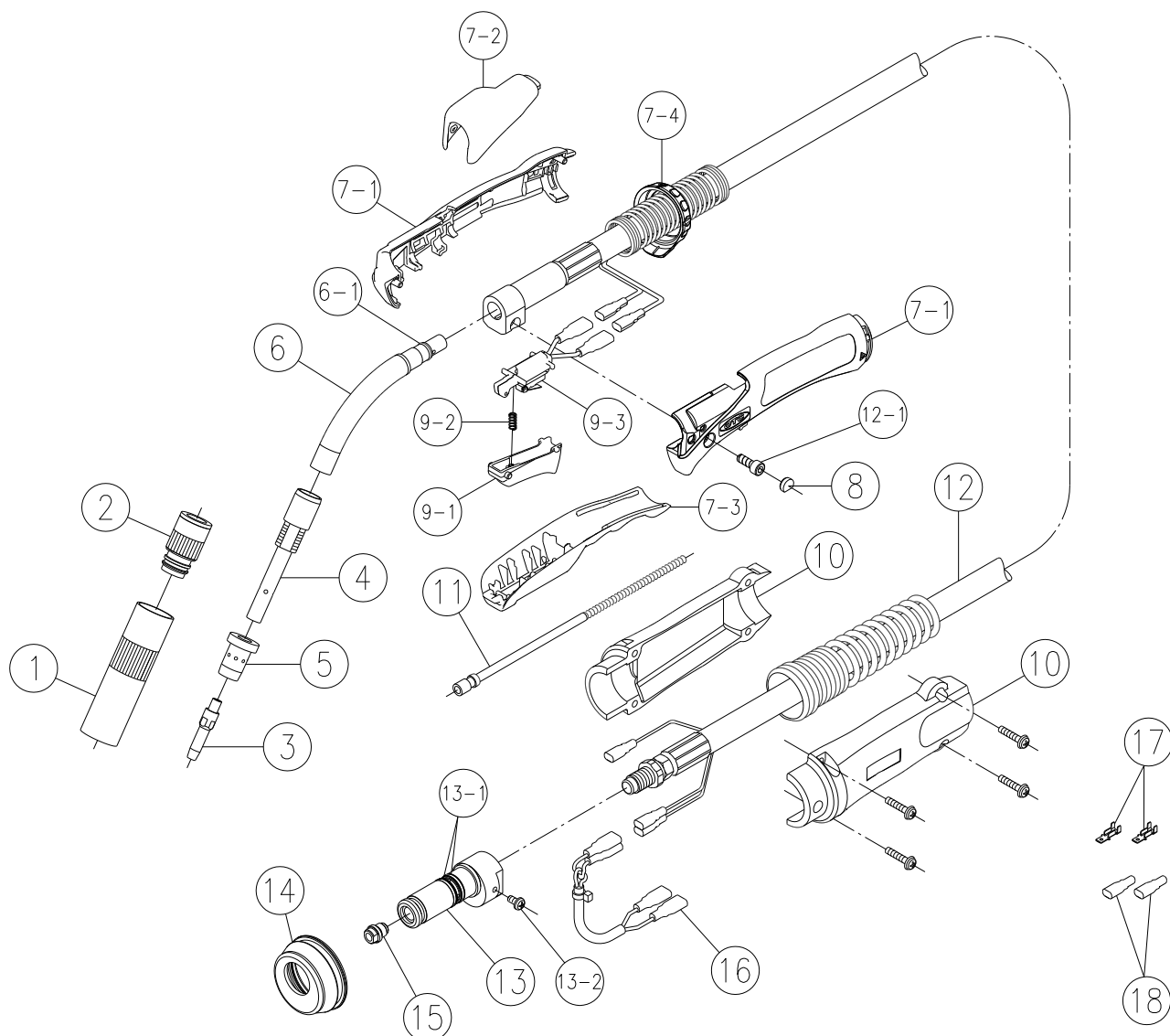



No.	Part Description	Part No.	No.	Part Description	Part No.
①	Nozzle (I.D.16mm)	U4167G01	⑩	Cable Support (with Screw)	U6190S00
②	Insulator	U4167L00	⑪	Liner	
③	Contact Tip (1.2mm/.045")	K980C26		3.0m/10ft (0.9~1.2mm/.035"~.045")	U4170H02
④	Tip Body	U4167G03		4.5m/15ft (1.0~1.2mm/.040"~.045")	U6194L00
⑤	Orifice	U4167G02		6.0m/20ft (1.2mm/.045")	U6195L00
⑥	Torch Body (R77,55°)	U6196B00	⑫	Power Cable (Screw, Reinforcing Spring is included.)	
⑥-1	O-Ring (S9-4D)	3574-001		3.0m/10ft	U6196D00
⑦	Handle KIT (⑦-1~4 is included.)	U6256C00		4.5m/15ft	U6197D00
⑦-1	Handle (L/R)	U6256D00		6.0m/20ft	U6198D00
⑦-2	Handle (Upper)	U6196H03	⑫-1	Bolt with hole (M5X14)	100-0310
⑦-3	Handle (Lower)	U6196H04	⑬	Power Fitting "NO.4" (with Screw)	U5972E00
⑦-4	LockRing	U6196H05	⑬-1	O-Ring (AS-014(4D))	100-0818
⑧	Cap	U5341G01	⑬-2	Small Screw (M4X8)	100-0297
⑨	Trigger ASSY (⑨-1~3 is included.)	U6190T00	⑭	Rubber Sleeve	U5972G01
⑨-1	Trigger	U6190T01	⑮	Wire Guide (0.9~1.2mm/.035"~.045")	U5972G02
⑨-2	Trigger Spring	U157E04	⑯	Switch Cord	U5972F00
⑨-3	Switch ASSY	U6190Q00	⑰	Terminal (LOM-21T-187)	100-0820
			⑱	Cap (253224)	100-0821

Optional Parts List

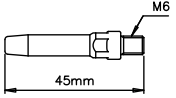
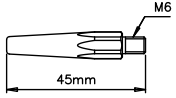
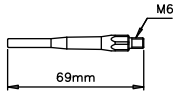
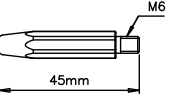
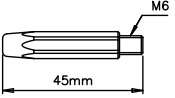

※The dimension of the drawing is a reference value.

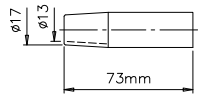
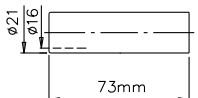
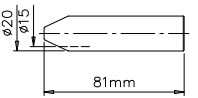
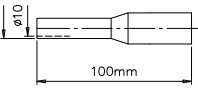
UNIT (mm)

Contact Tip					
	A-Tip (Standard)	T-Tip (High Current)	Long Tip	CW-Tip (Long Life)	Heavy Current
Wire Size					
0.9mm (.035")	K980C24	K662B12	U4167H07	-	U4167H14
1.0mm (.040")	K980C25	K980C17	U4167H06	-	U4167H13
1.2mm (.045")	K980C26 K980C73 (For FCW)	K980C19	U4167H05	K990E12	U4167H12
1.4mm (.052")	K980C27 K980C74 (For FCW)	K980C20	-	K990E14	U4167H11

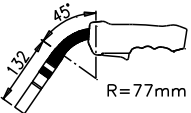
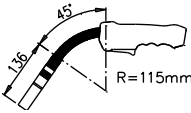
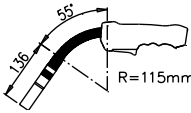
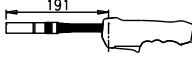
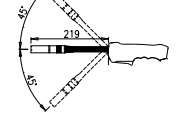
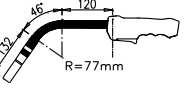
Nozzle				Heat Shield	
Low Current	High Current	Arc Spot	Deep and Narrow Space	Standard	For "Pistol Grip Handle"
U4167H01	U4167H16	U4170H01	U4167H04	U6256H00	U6256N00
					
			Combine with Long Tip.		

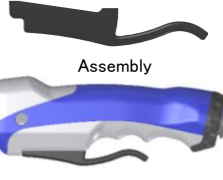
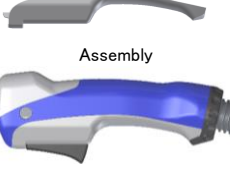
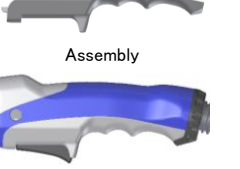
Torch Body					
R77, 45°	R115, 45°	R115, 55°	Straight	Flexible	Long Neck
U5347B00	U5350B00	U6199B00	U5339H00	U5339L00	U5339N00
					
				Inner liner is required.	

Modular Torch Handle/Trigger Options				(tool-less/quick-change style)	
Extended Trigger	Slim Grip Handle	Trigger Guard Grip Handle	Pistol Grip Handle Kit		
U6256T00	U6256B01	U6256B02	U6256K00	Assembly	
					
Assembly	Assembly	Assembly			

Wire Guide	
Wire Size	Part No.
1.2~1.6mm .045"~1/16"	U5978G02

※1 "Extended Trigger" is not made in combination with "Trigger Guard Grip Handle" and "Pistol Grip Handle Kit".
 ※2 "Switch ASSY(U6190Q00)" and "Trigger Spring(U157E04)" are not included in "Extended Trigger".
 ※3 "Trigger ASSY(U6190T00)" is not included in "Slim Grip Handle" and "Trigger Guard Grip Handle".
 ※4 Please order "U6256M00" towards "Trigger ASSY(U6190T00)" is not required to "Pistol Grip Handle Kit".

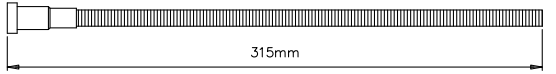
Inner Liner		
Wire Size	Part No.	These are available for the torch bodies above.
0.8~1.2mm/.030"~.045"	U5003L82	
1.2~1.6mm/.045"~1/16"	U5003L26	
		

Liner		
Wire Size	Length	Part No.
1.2~1.6mm/.045"~1/16"	3.0m/10ft	U6199L00
1.2~1.6mm/.045"~1/16"	4.5m/15ft	U6200L00
1.2~1.6mm/.045"~1/16"	6.0m/20ft	U6201L00

■ Voltage Detecting Cable
Part No. :U 5 3 6 5 P 0 0

※In order to use voltage detecting cable, you will need to modify the welding power source and wire feeder.
For detail, see owner's manual of the welding power source and wire feeder.

